



Spectrum

CE SYSTEM





Discover the CE You've Been Missing.

Designed for STR analysis, the Spectrum CE System is built to streamline and support your forensic and paternity workflow needs. Spectrum CE System combines state-of-the-art STR analysis functionality with increased run flexibility, user-friendly software, and the service and support you've come to trust from Promega. Spectrum is designed for use with existing 5- and 6-dye STR kits from Promega and Applied Biosystems. It also supports the next generation of 8-color STR kits.

More Efficient Operation

With four 96-well plate positions and continuous plate accessibility, Spectrum offers increased productivity and scheduling flexibility, with no loss of efficiency during partial plate runs. Batching and sign up sheets can be a thing of the past—freeing up your team to work on more valuable tasks.

Integrated data collection and analysis software provides automatic data quality assessment, reducing the time needed to screen for reinjections.



**Spectrum CE System
has capacity for up to
four plates of samples,
including the ability to
run a partial plate.**



Advanced Multiplexing Capabilities: More Information from Challenging Samples

Spectrum is the first CE system to support the next generation of PowerPlex® 8-dye STR Systems. These new PowerPlex® Systems enable amplification and detection of more loci from challenging casework samples, resulting in more meaningful analyses.

Labs using the 8-dye systems can also expect more consistent results from variable database and reference samples, due to the narrower range of product amplicon sizes.

More Mini-STRs for Improved Success with Difficult Samples

The PowerPlex® 35GY System allows co-amplification and fluorescent detection of the 20 CODIS Core Loci plus Amelogenin and DYS391 for gender discrimination. Penta D, Penta E and SE33 also are included to increase discrimination and allow searching of databases that contain profiles with these loci. With the two additional colors for detection, there are a total of 15 autosomal loci smaller than 250bp, aiding the analysis of difficult samples.

Additionally, we've designed the layout to allow smaller amplicon sizes for these particularly informative loci: SE33, D21S11 and D2S1338. Ten additional Y-STR loci are included to assist with forensic casework on sexual assault evidence or to enable familial searching, a technique known for its ability to provide investigative leads.

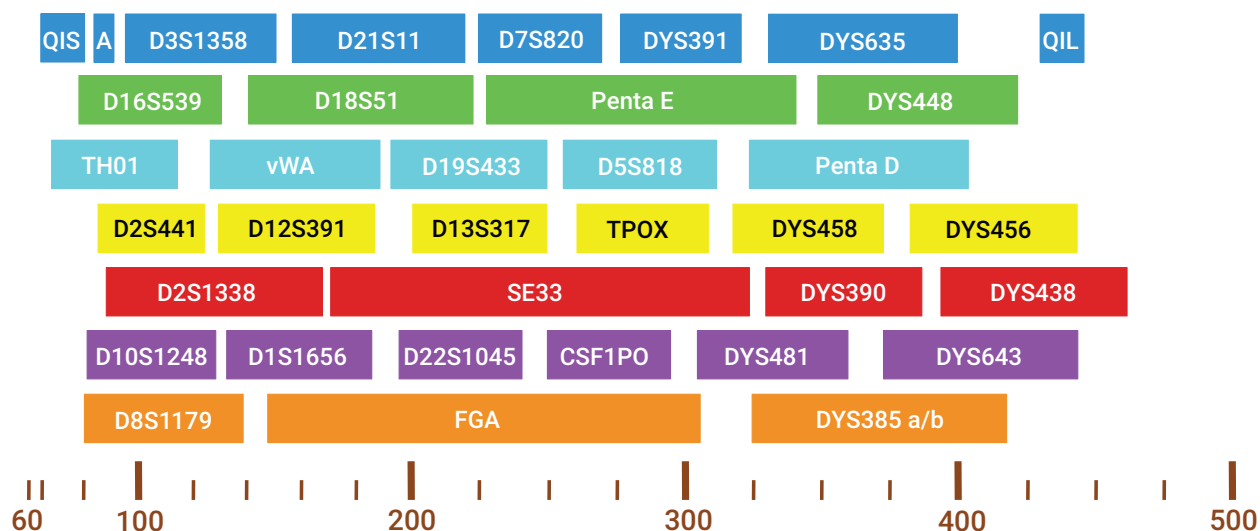

Configuration of the PowerPlex® 35GY System. The PowerPlex® 35GY System allows co-amplification and detection of 35 loci (24 autosomal and 11 Y-STR loci) CSF1PO, D3S1358, D5S818, D7S820, D8S1179, D13S317, D16S539, D18S51, D21S11, FGA, TH01, TPOX, vWA, D1S1656, D2S441, D2S1338, D10S1248, D12S391, D19S433 and D22S1045, SE33, Penta D, Penta E and Amelogenin; DYS391, DYS385a/b, DYS390, DYS438, DYS448, DYS456, DYS458, DYS481, DYS635 and DYS643. Two Quality Indicators (QIS and QIL) are also included to assist with data interpretation.



High Quality Results from All Your Samples

Designed to work exclusively on the Spectrum CE System, the PowerPlex® 35GY System is compatible with both extracted DNA and direct amplification samples.

The kit offers optimized protocols for various sample types, including direct amplification from FTA® cards and pretreated non-FTA® card punches or swabs in both full-volume (25µl) and half-volume (12.5µl) reactions. The figure below shows results from a cotton swab buccal sample in which the DNA from that swab was amplified directly using a half-volume reaction.

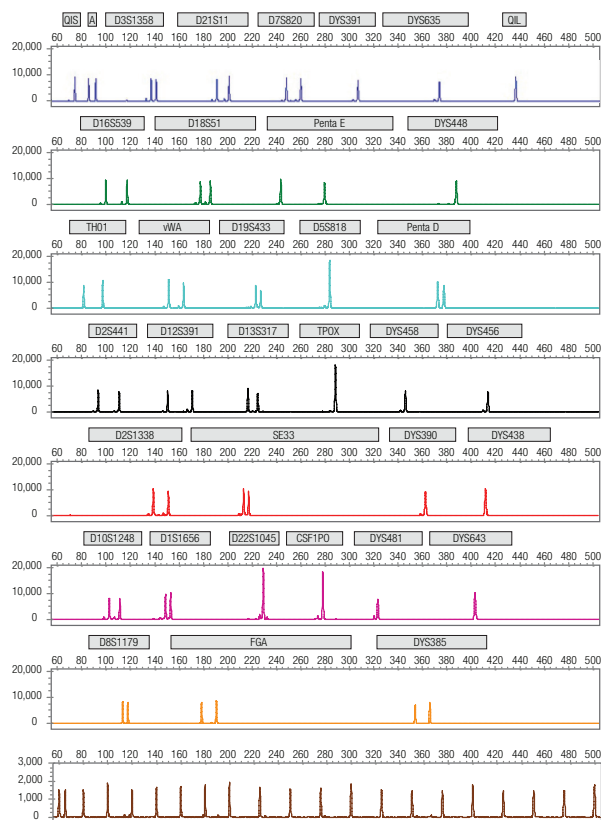

DNA from a buccal swab in Swab Solution™ Reagent was amplified with the prototype PowerPlex® 35GY System in a 12.5µl reaction. Amplification products were separated on the Spectrum CE system.

More Information for Improved Decision Making

New in the 8-color PowerPlex® systems is the inclusion of two Quality Indicators to assess the presence of inhibitors, designed to minimize the need to repeat unusable or poor STR analyses that resulted from inhibited DNA. The two Quality Indicator peaks (QIS and QIL) provide data interpretation assistance, by delivering more information about the sample, such as whether or not it was degraded or inhibited.

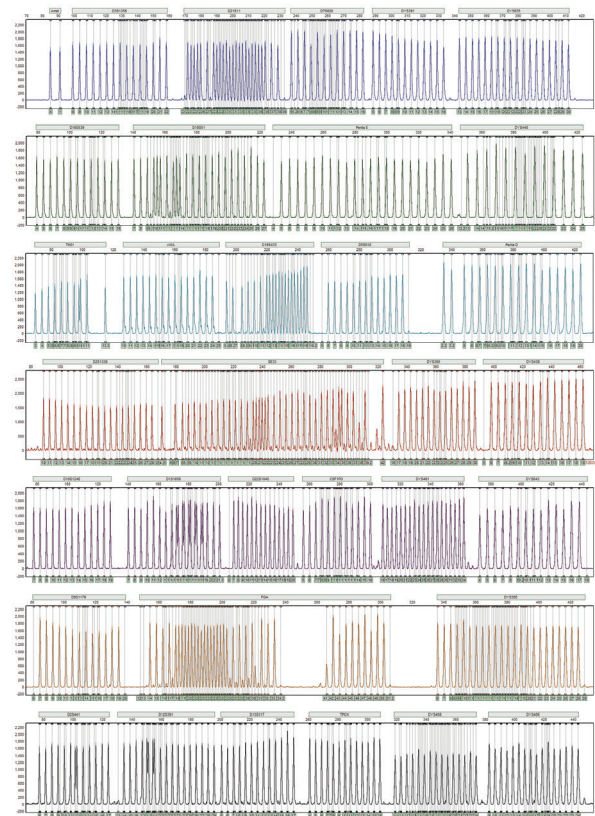

2800M Control DNA (1ng) was amplified with the prototype PowerPlex® 35GY System. Amplification products were separated using the Spectrum CE System.



Compatible with the Kits You Already Love

Spectrum CE System is the first CE system to support 8-dye technology. However, if your laboratory is satisfied with an existing 5- or 6-color kit you've already brought online, the Spectrum CE System has got you covered. You'll be able to continue using those same multiplexes and still benefit from the increased throughput and flexibility that the Spectrum CE enables.

The following figures demonstrate the solid performance of the Spectrum CE System when running samples amplified with the PowerPlex® Fusion 6C System and GlobalFiler® PCR Amplification Kit.

PowerPlex® Fusion 6C System

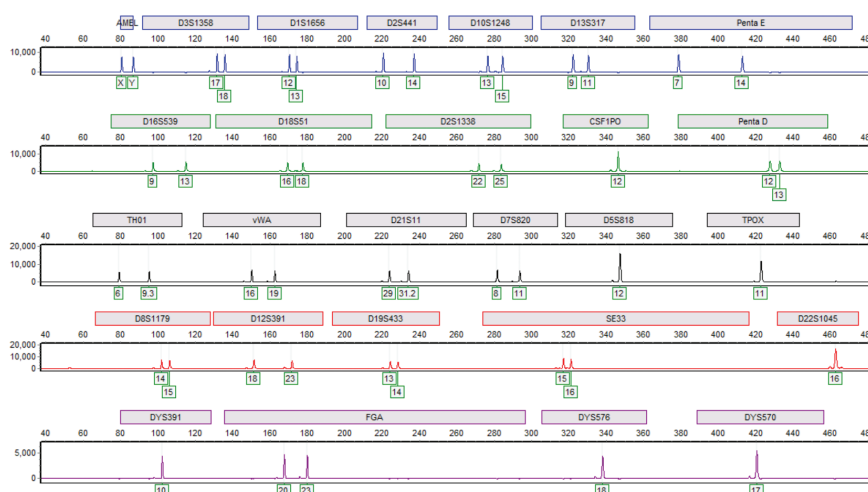

2800M Control DNA (1ng) was amplified with PowerPlex® Fusion 6C System. Amplification products were separated using the Spectrum CE System.

GlobalFiler® PCR Amplification Kit

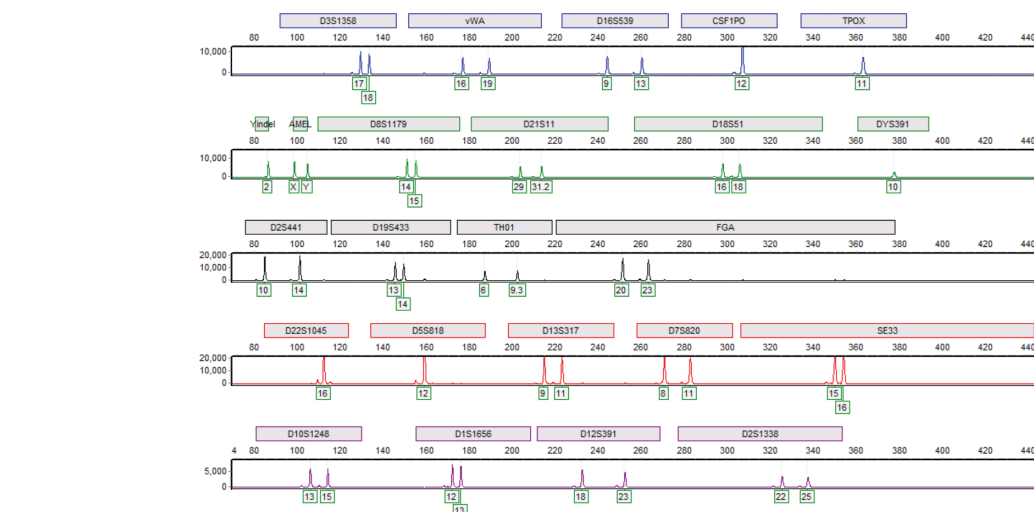

2800M Control DNA (1ng) was amplified with GlobalFiler® PCR Amplification Kit. Amplification products were separated using the Spectrum CE System.



Full Complement of Consumables and Accessories

We've designed the Spectrum CE System to provide simplified setup and operation. Related consumables, such as pre-filled buffer and polymer, will be offered in convenient, ready-to-use packaging.

Spectrum uses Radio Frequency Identification (RFID) to track key consumables with minimal "hard stops" limited to situations where there is a risk of instrument damage.



**Consumables are sold
in a ready to use format,
so the lab can get up and
running in no time.**



Automatic Sample Tracking

Spectrum features automatic recording of plate barcodes and auto-import of plate map files with matching barcode information—making import of sample names a one-click process. This feature is supported by novel plate holders that allow barcode visibility when fully assembled and in the instrument. There is less opportunity for error, with an exact record of plates analyzed, and easier, faster operation.

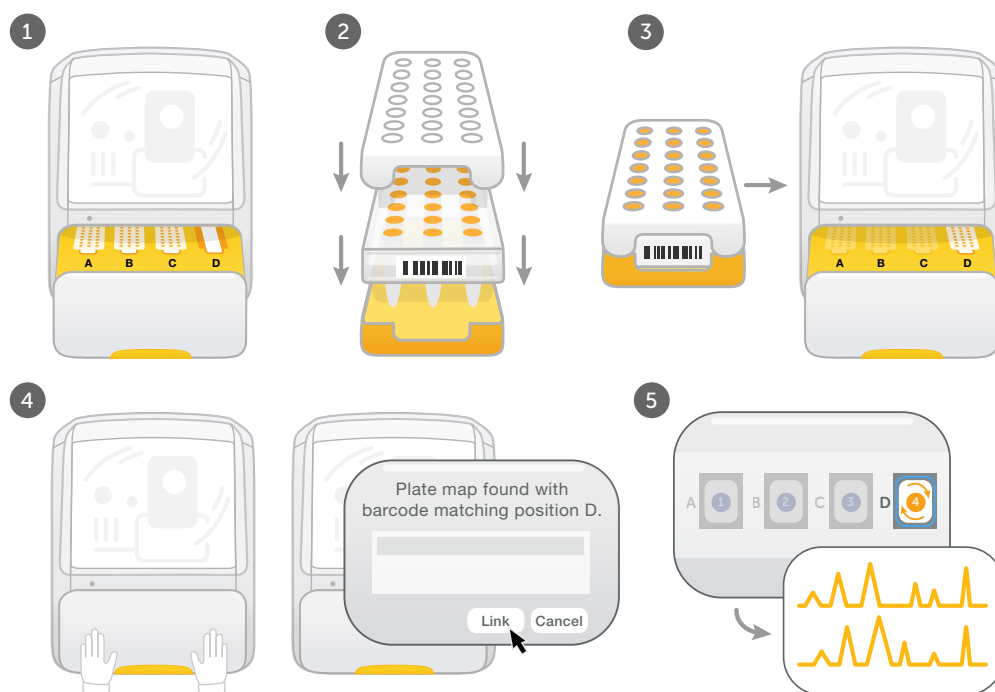

Promega Support—With You at Every Step

Promega chemistry and hardware are integrated to provide optimized results for the Spectrum CE System. We offer on-site installation and training for the instrument, software and STR kits, as well as timely on-site repair and preventative maintenance service to ensure minimal interruption of your laboratory operations.

Our Validation Services team can provide a range of services, designed to meet your laboratory's needs and your preferred scope of work:

- Phone-based and on-site consultation
- On-site bench work tailored to your requirements
- Rapid turnaround of data analyses and summary reports



Easy-to-use Instrument Control and Data Software

System Software

The Spectrum Control Software provides a simple user interface with a clear display of useful features, including run scheduling, consumables and array usage information. The software's ease of use can reduce training time and daily operation effort.

The Spectrum CE System was designed with forensic laboratories in mind to make CE analysis as easy as it gets. An experienced CE user can be up and running on the instrument within an hour. New users will also find the software to be intuitive and easy to understand.

Spectrum CE System comes loaded with features to have you quickly running analyses. Because less training time for proficient use is needed, more time can be focused on preparing samples and analysis.





Use the Analysis Software of Your Choice

The Spectrum CE System can create .fsa and .promega output files for sample analysis. The instrument's .fsa output for existing 5- or 6-color multiplexes is compatible with GeneMapper® ID-X and GeneMarker® HID Software for Spectrum analysis packages. Labs can generate .promega output for 5- or 6-color multiplexes, new 8-color multiplexes, and use it with GeneMarker®HID-Spectrum analysis software.

GeneMarker® HID Software for Spectrum CE Systems is designed for human identification and forensics applications. It includes “expert system” functionality—delivering accurate STR sizing and allele calling in both user-mediated and fully automated expert system analysis approaches at an affordable price point. In addition to fast, accurate and user-friendly STR analysis, the software provides various modules for improved analysis.

Simplified User Operation

The software's intuitive design ensures that it's easy to use, regardless of the user's experience level. The program reduces user intervention by up to 25% by automatically correcting for most chemistry errors such as stutter, peak saturation, bleed through, noise and instrument spikes.

The linked navigation and “point and click” interface makes the software simple to follow and reduces analyst fatigue. Run Wizard includes pre-installed templates for each amplification kit, eliminating the need to import panels, bins and stutter files. Analysis templates are easily saved and shared with all members of the laboratory.

Broad Kit Compatibility

Compatible with major commercially available STR chemistries, the software supports analysis of Spectrum (.promega) and existing capillary electrophoresis (CE) data (.fsa and .hid) files.

User Management with Audit Trail

Users can be confident and secure when using GeneMarker® HID Software for Spectrum. Equipped with password control, an extensive user management system and a built in audit trail, the software ensures that unauthorized individuals are unable to inadvertently modify a project or settings.

A wide range of reporting options are available to meet LIMS and report printing needs. Analysis and display options are customizable and enable easy follow up and tracking.





System Components

The Spectrum CE System is supplied as follows:

- Capillary electrophoresis instrument
- Starter Kit for installation and training
- Computer workstation and high-definition, flat-screen monitor
- Includes one (1) license each: Spectrum Control Software, HIDAuto for Spectrum CE Systems and instrument workstation-specific version of GeneMarker®HID Software for Spectrum CE Systems
- On-site service for installation and initial user training
- 12 month warranty, including on-site repair service with one preventative maintenance visit

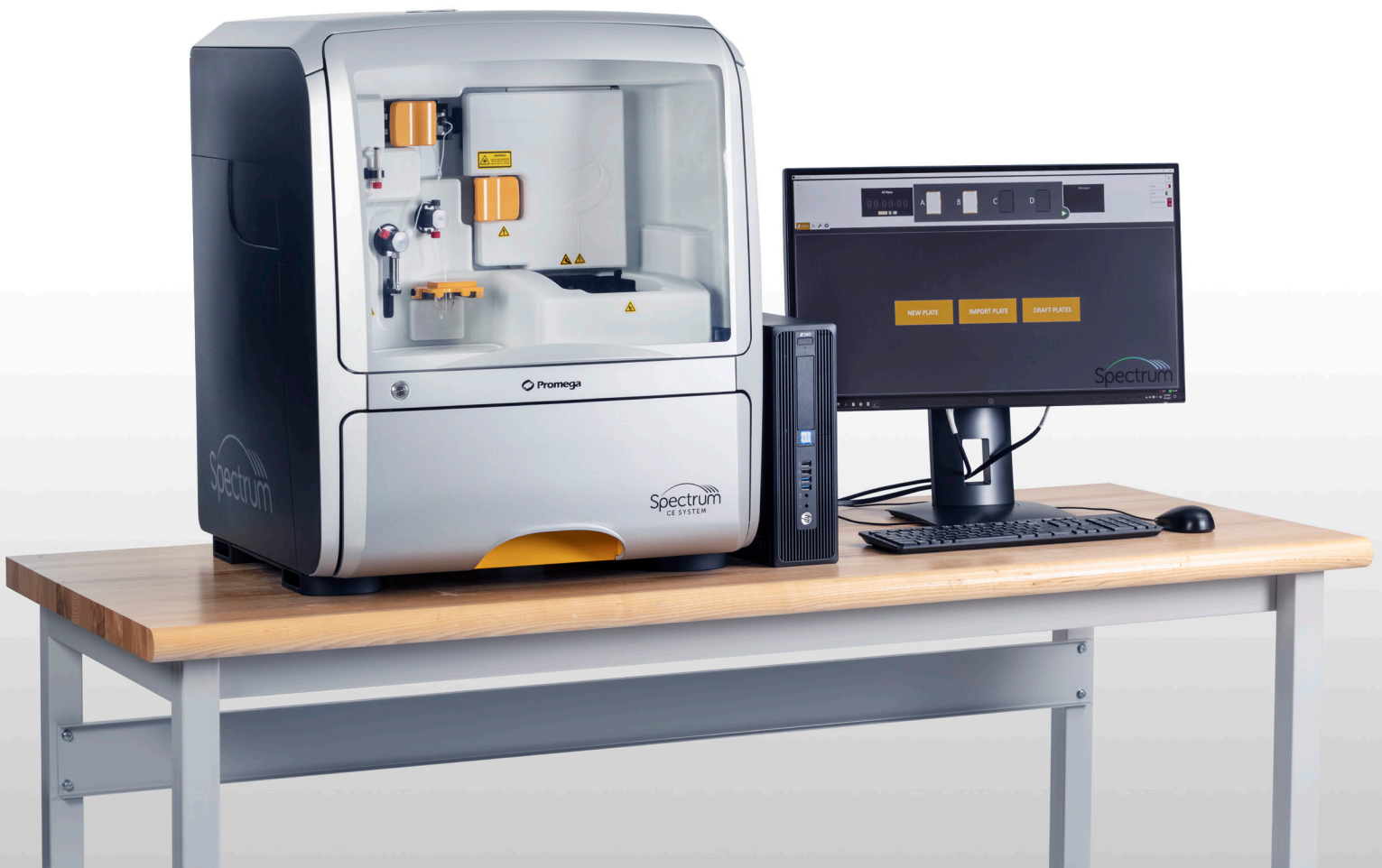



Specifications

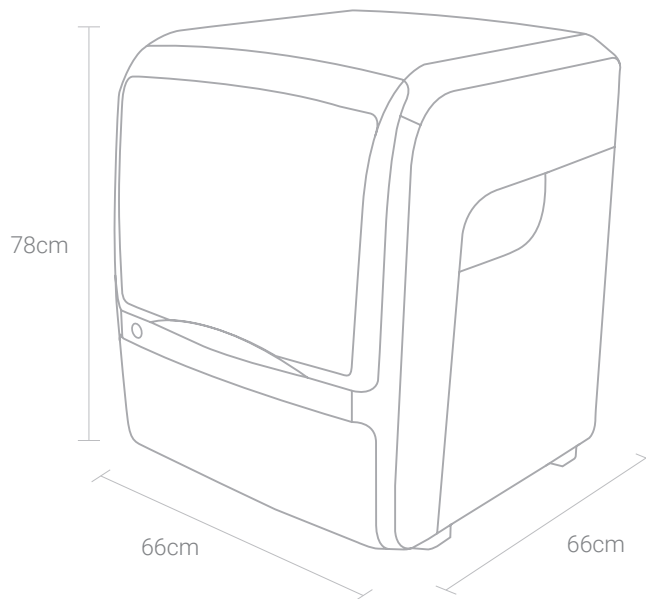

Approximate Dimensions	Overall: 66cm W × 66cm D × 78cm H Footprint: 62cm W × 48cm D
Weight	Approximately 104kg (external computer excluded)
Main Power Voltage	100-120/200-240 VAC (global compatibility) 15 amps
Operating Environment	15°C to 30°C
Plate Capacity	Up to 4 plates, with semi-continuous accessibility
STR Chemistry	Optimized for use with existing 5- and 6-color STR kits Supports next generation of 8-dye PowerPlex® Systems
Service and Warranty	1-year limited warranty on parts and labor Service installation On-site training Extended service contract agreements are also available separately—please enquire
Validation Support	Available separately—please enquire

To learn more, visit:

www.promega.com/MeetSpectrum



To learn more about GeneMarker®HID Software, visit:

www.softgenetics.com

PowerPlex is a registered trademark of Promega Corporation.

GeneMarker is a registered trademark of SoftGenetics.

ThermalSeal is a registered trademark of Excel Scientific, Inc.

Not for Medical Diagnostic Use. Class 1 Laser Product.

Products may be covered by pending or issued patents or may have certain limitations.
Please visit our Web site for more information.



PROMEGA CORPORATION · 2800 WOODS HOLLOW ROAD · MADISON, WI 53711-5399 USA · TELEPHONE 608-274-4330

WWW.PROMEGA.COM · ©2022 PROMEGA CORPORATION · ALL RIGHTS RESERVED · PRICES AND SPECIFICATIONS SUBJECT TO CHANGE WITHOUT PRIOR NOTICE · REVISED 04/22 · 65853513 · PART #BR284